

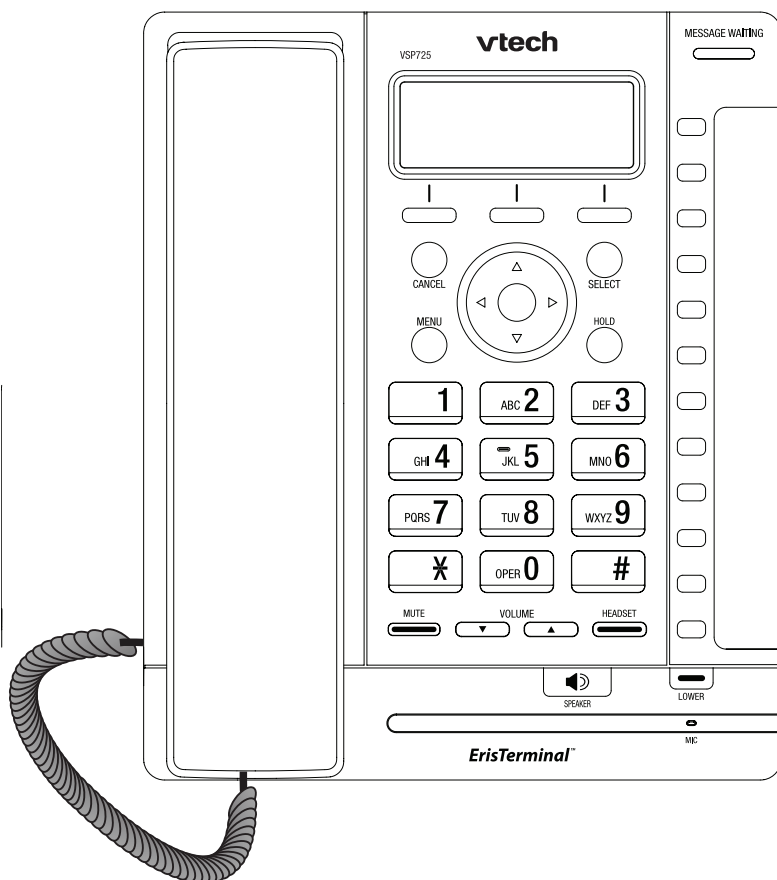

Quick Start Guide

VSP725

SIP Endpoint Deskset



Important Safety Information



This symbol is to alert you to important operating or servicing instructions that may appear on the product or in this user's manual. Always follow basic safety precautions when using this product to reduce the risk of injury, fire, or electric shock.

Important Safety Instructions

When using your telephone equipment, basic safety precautions should always be followed to reduce the risk of fire, electric shock and injury, including the following:

1. This product should be installed by a qualified technician.
2. This product should only be connected to the host equipment and never directly to the network such as Public Switch Telephone Network (PSTN) or Plain Old Telephone Services (POTS).
3. Read and understand all instructions.
4. Follow all warnings and instructions marked on the product.
5. Unplug this product from the wall outlet before cleaning. Do not use liquid or aerosol cleaners. Use a damp cloth for cleaning.
6. Do not use this product near water such as near a bath tub, wash bowl, kitchen sink, laundry tub or swimming pool, or in a wet basement or shower.
7. Do not place this product on an unstable table, shelf, stand or other unstable surfaces.
8. Slots and openings in the back or bottom of the telephone base and handset are provided for ventilation. To protect them from overheating, these openings must not be blocked by placing the product on a soft surface such as a bed, sofa or rug. This product should never be placed near or over a radiator or heat register. This product should not be placed in any area where proper ventilation is not provided.
9. This product should be operated only from the type of power source indicated on the marking label. If you are not sure of the type of power supplied at the premises, consult your dealer or local power company.
10. Do not allow anything to rest on the power cord. Do not install this product where the cord may be walked on.
11. Never push objects of any kind into this product through the slots in the telephone base or handset because they may touch dangerous voltage points or create a short circuit. Never spill liquid of any kind on the product.

12. To reduce the risk of electric shock, do not disassemble this product, but take it to an authorized service facility. Opening or removing parts of the telephone base or handset other than specified access doors may expose you to dangerous voltages or other risks. Incorrect reassembling can cause electric shock when the product is subsequently used.
13. Do not overload wall outlets and extension cords.
14. Unplug this product from the wall outlet and refer servicing to an authorized service facility under the following conditions:
 - A. When the power supply cord or plug is damaged or frayed.
 - B. If liquid has been spilled onto the product.
 - C. If the product has been exposed to rain or water.
 - D. If the product does not operate normally by following the operating instructions. Adjust only those controls that are covered by the operation instructions. Improper adjustment of other controls may result in damage and often requires extensive work by an authorized technician to restore the product to normal operation.
 - E. If the product has been dropped and the telephone base and/or handset has been damaged.
 - F. If the product exhibits a distinct change in performance.
15. Avoid using a telephone (other than cordless) during an electrical storm. There is a remote risk of electric shock from lightning.
16. Do not use the telephone to report a gas leak in the vicinity of the leak. Under certain circumstances, a spark may be created when the adapter is plugged into the power outlet, or when the handset is replaced in its cradle. This is a common event associated with the closing of any electrical circuit. The user should not plug the phone into a power outlet, and should not put a charged handset into the cradle, if the phone is located in an environment containing concentrations of flammable or flame-supporting gases, unless there is adequate ventilation. A spark in such an environment could create a fire or explosion. Such environments might include: medical use of oxygen without adequate ventilation; industrial gases (cleaning solvents; gasoline vapors; etc.); a leak of natural gas; etc.
17. Only put the handset of your telephone next to your ear when it is in normal talk mode.
18. The power adapters are intended to be correctly oriented in a vertical or floor mount position. The prongs are not designed to hold the plug in place if it is plugged into a ceiling, under-the-table or cabinet outlet.

19. Use only the power cord indicated in this manual.
20. In wall mounting position, make sure to mount the telephone base on the wall by aligning the eyelets with the mounting studs of the wall plate. Then slide the telephone base down on both mounting studs until it locks into place. Refer to the full instructions in **Deskset Installation** in the User Guide.
21. CAUTION: Keep small metallic objects such as pins and staples away from the handset receiver.

SAVE THESE INSTRUCTIONS

Compliance

FCC part 15

This device complies with Part 15 of the FCC rules. Operation is subject to the following two conditions: (1) This device may not cause harmful interference, and (2) this device must accept any interference received, including interference that may cause undesired operation.

This equipment has been tested and found to comply with the limits for a Class A digital device, pursuant to Part 15 of the FCC Rules. These limits are designed to provide reasonable protection against harmful interference when the equipment is operated in a commercial environment. This equipment generates, uses, and can radiate radio frequency energy and, if not installed and used in accordance with the instruction manual, may cause harmful interference to radio communications. Operation of this equipment in a residential area is likely to cause harmful interference in which case the user will be required to correct the interference at the user's expense.

This Class A digital apparatus complies with Canadian ICES-003.

Cet appareil numérique de la classe A est conforme à la norme NMB-003 du Canada.

Industry Canada

Operation is subject to the following two conditions: (1) this device may not cause harmful interference, and (2) this device must accept any interference, including interference that may cause undesired operation of the device.

Privacy of communications may not be ensured when using this telephone.

The term "IC:" before the certification/registration number only signifies that the Industry Canada technical specifications were met.

This product meets the applicable Industry Canada technical specifications.

About this Guide

This quick start guide provides a reference for the external features of the phone and basic installation instructions.

Please refer to the VSP725 Deskset User Guide for complete installation and operation instructions. You can download the guide from

businessphones.vtech.com.

For customer service or product information, visit our website at

businessphones.vtech.com or call **1 (888) 370-2006.**

Parts Checklist

Your telephone package contains the following items. Save your sales receipt and original packaging in the event warranty service is necessary.

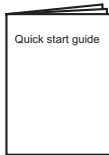

Quick Start Guide

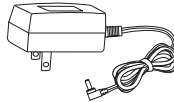

Power adapter

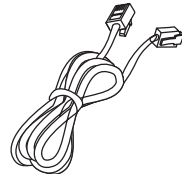

Ethernet cable

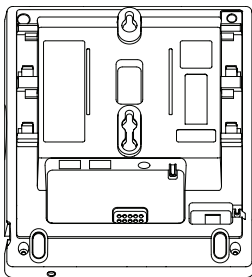

Deskset base

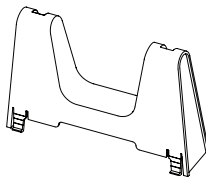

Deskset stand

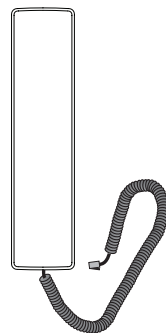

Handset and handset cord

Quick Reference Guide

External Features

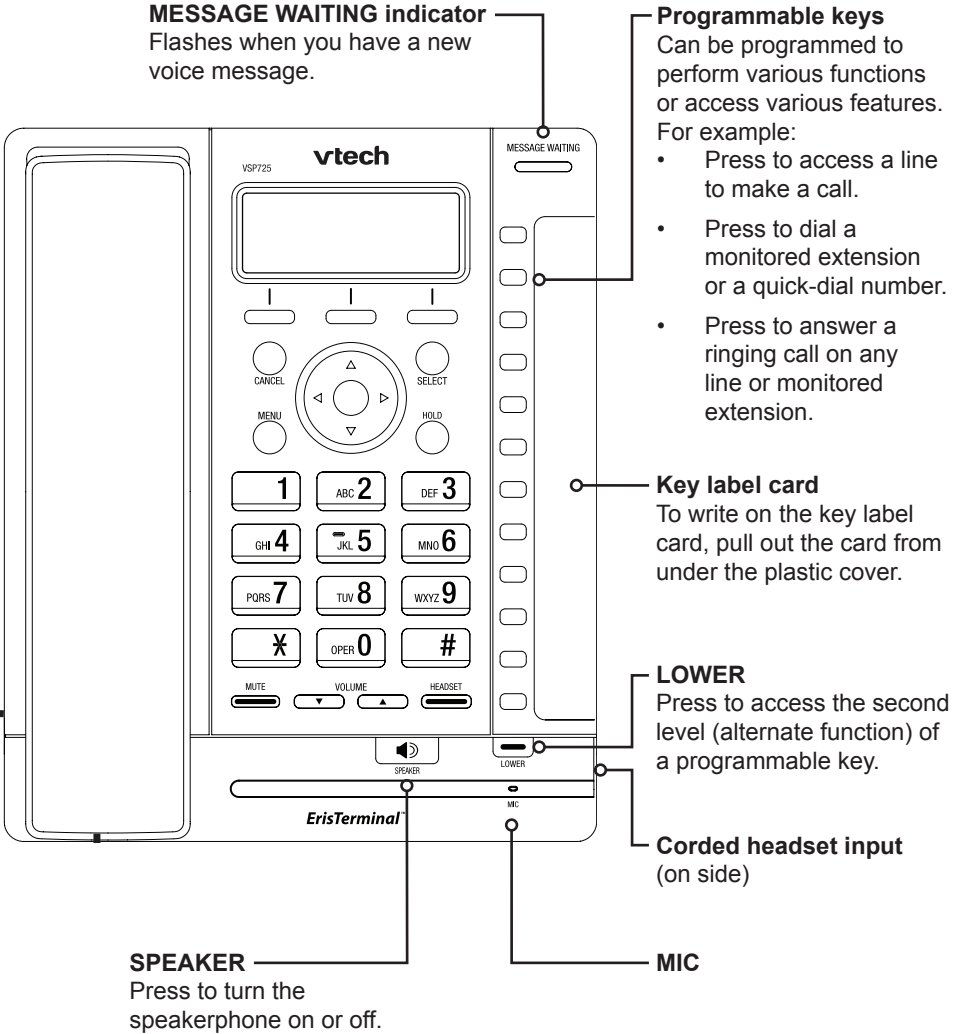

Quick Reference Guide

Screen and Navigation Controls

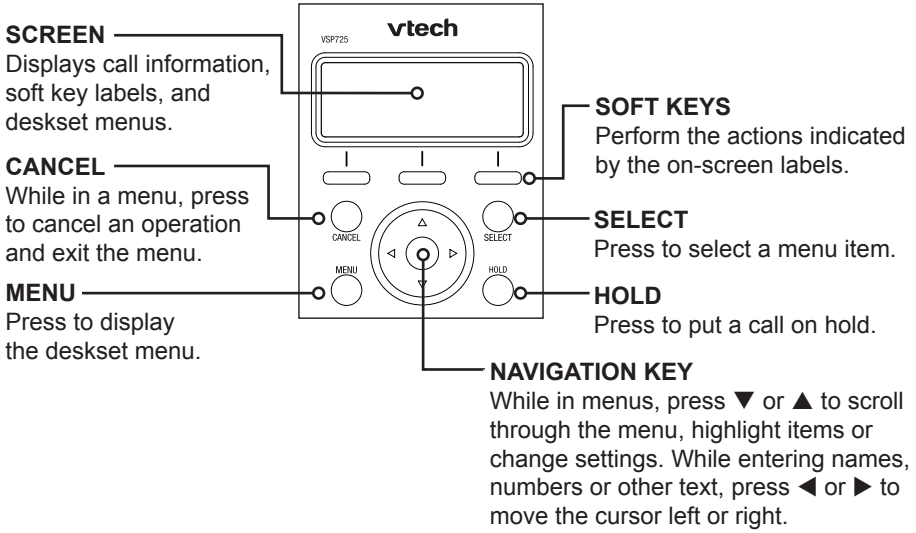

Dial Pad and Audio Controls

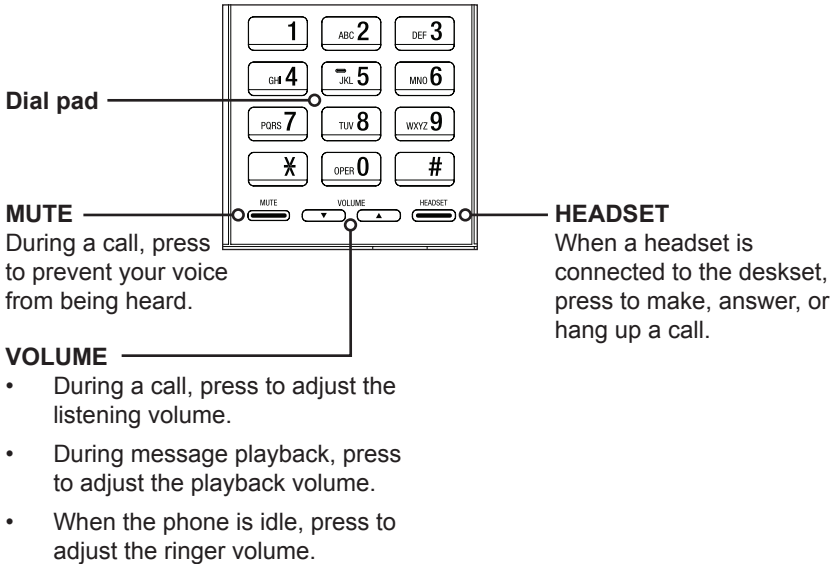

Quick Reference Guide

Back Panel Features

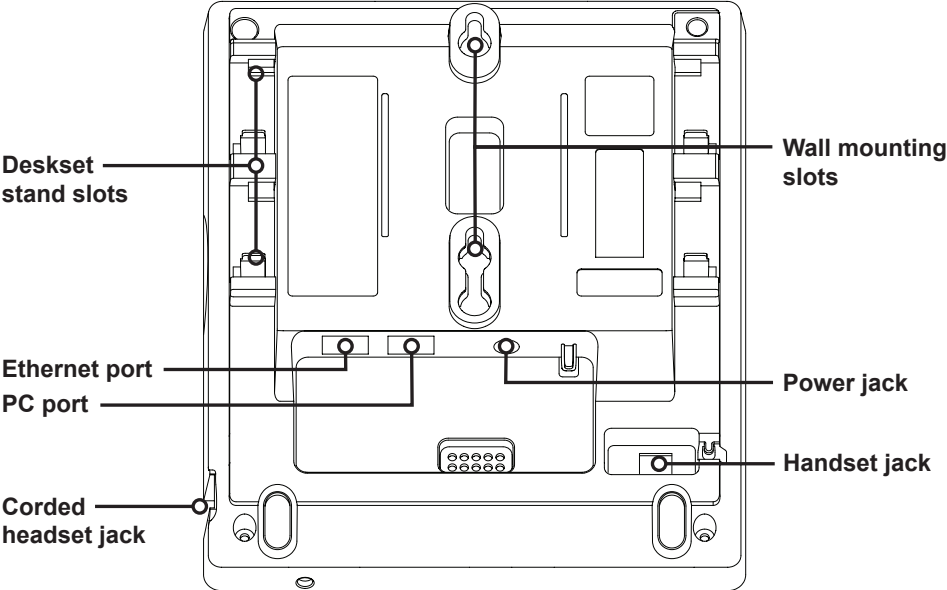

Deskset Installation

This section assumes that your network infrastructure is established and that your IP PBX phone service has been ordered and configured for your location. For more information about installation options and phone setup, see the VSP725 Deskset User Guide and the VSP725 Deskset Administrator and Provisioning Manual, available at businessphones.vtech.com.

You can power the phone using the supplied power adapter or using Power over Ethernet (PoE) from your network. If you are not using PoE, install the phone near a power outlet not controlled by a wall switch. The phone can be placed on a flat surface or vertically mounted on the wall.

Avoid placing the deskset too close to:

- Communication devices such as television sets, DVD players, or other cordless telephones
- Excessive heat sources
- Noise sources such as a window with traffic outside, motors, microwave ovens, refrigerators, or fluorescent lighting
- Excessive dust sources such as a workshop or garage
- Excessive moisture
- Extremely low temperature
- Mechanical vibration or shock such as on top of a washing machine or work bench.

To install the phone:

1. If you plan to place the phone on a flat surface, attach the stand. Line up the tabs on the stand with the slots on the rear of the phone. Two sets of slots allow you to attach the stand at either a 45-degree or 35-degree angle. To wall mount the phone, see the VSP725 Deskset User Guide.

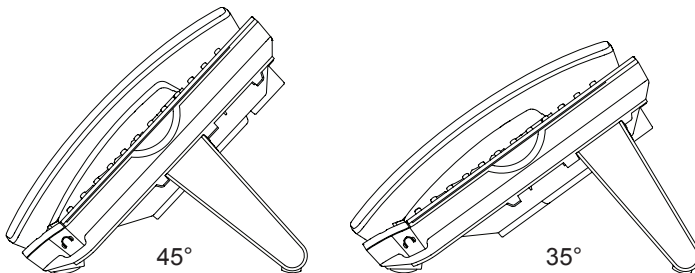

2. Plug the end of the coiled handset cord into the Handset jack on the rear of the phone. Secure the cord by routing it through the slot and underneath the tab.

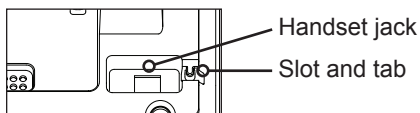

3. Plug one end of the Ethernet cable into the Ethernet port on the rear of the deskset (marked by ) , and plug the other end of the cable into your network router or switch.

If the deskset is not using power from a PoE-capable network router or switch:

- a. Connect the supplied power adapter to the deskset power jack.
- b. Plug the power adapter into an electrical outlet that is not controlled by a wall switch.

IMPORTANT INFORMATION

1. Use only the power adapter supplied with this product. To order a replacement power adapter, visit our website at **businessphones.vtech.com** or call **1 (888) 370-2006**.
2. The power adapter is intended to be correctly oriented in a vertical or floor mount position. The prongs are not designed to hold the plug in place if it is plugged into a ceiling, under-the-table or cabinet outlet.

If there is a networked computer and no extra Ethernet wall ports near the phone, then the phone and PC can share the same network connection.

To share a network connection with a PC:

1. Plug a Cat.-5 Ethernet cable into the PC port on the phone (marked by ).
 2. Plug the other end of the Cat.-5 Ethernet cable into your computer's Ethernet port.
- If a GigE network is being used, a computer connected through the phone will be limited to 100 Mbits/s. If you require a GigE Ethernet rate, use separate Ethernet connections for the phone and the computer.
 - If a PC is connected to your network through a phone, any phone resets and power or network interruptions will disrupt the PC's connection to the network.

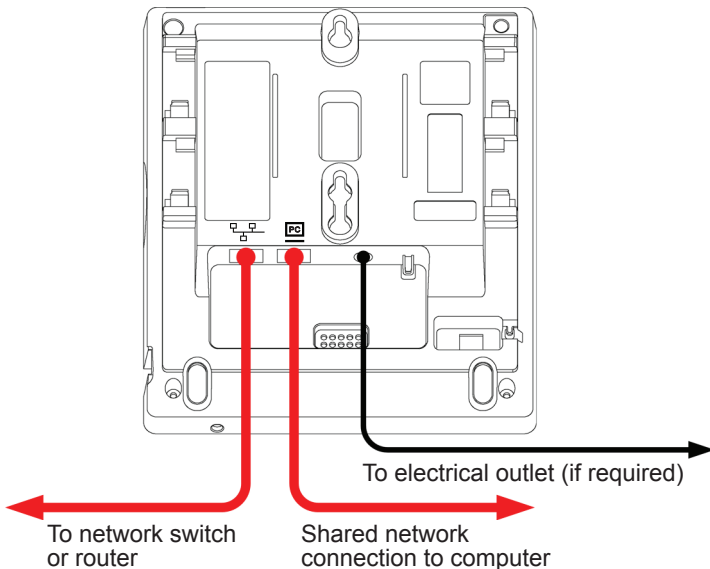

VTECH COMMUNICATIONS LTD.

A member of THE VTECH GROUP OF COMPANIES.

Distributed in the U.S.A. by VTech Communications Inc., Beaverton, Oregon 97008.

VTech is a registered trademark of VTech Holdings Limited.

Copyright © 2014 for VTECH COMMUNICATIONS LTD. All rights reserved.

Printed in China. Version 2, 02/14